

REVISION RECORD

REV	ECN	DESCRIPTION	DRFT	DATE
-----	-----	-------------	------	------

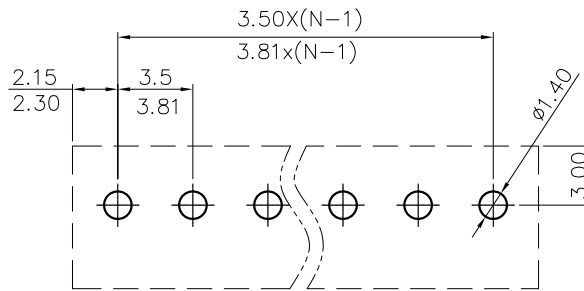
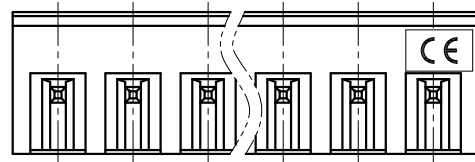

PCB LAYOUT

NOTES1:

UL Standard

1. Rated voltage/current : 300V / 8A
2. Withstanding voltage : AC1600V/1Min.

IEC Standard

1. Pollution Degree	2
Overvoltage Category	II
Rate Impulse Voltage(KV)	2.5KV
Rate Voltage(V)	250V
Rate Current(A)	7A

NOTES2:

1. Dimension shall be interpreted per ASME Y14.5-2009
2. Pitch : 3.5/3.81mm, Poles : N=02~24P
3. Operating temperature: -40°C~+105°C
4. Undimensioned tolerances:

Pitch range in mm		Nominal dimension range in mm				-	∩	□
TO	Over	Over	Over	Over	Over	TO	TO	TO
6	10	10	30	60	100	150		
±0.15	±0.20	±0.30	±0.30	±0.50	±0.70	±1.00	±1.30	±2"

5. RoHS Compliance

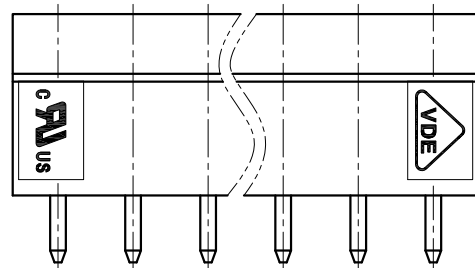
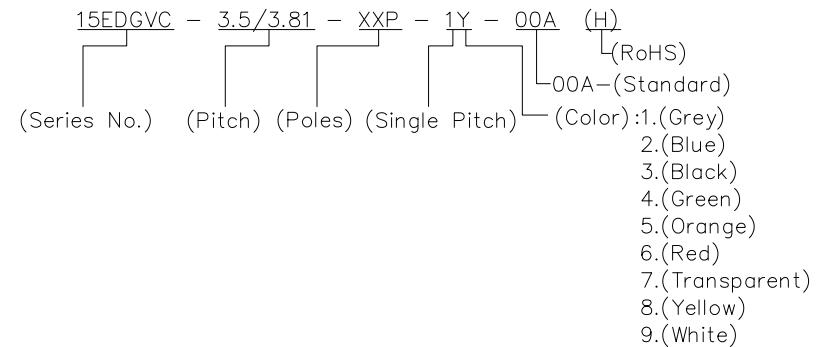
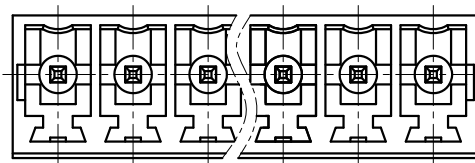
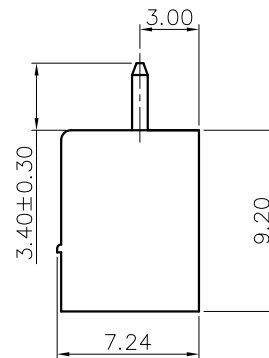
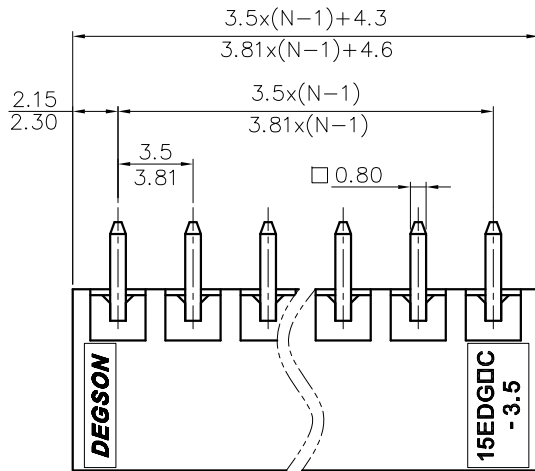

DETACHED LISTS	PART NO.:	/			
	APPD:	/			
	CHKD:	/			
	DRFT:	/			
	<p>THIRD ANGLE PROJECTION</p>		<p>MM (INCH)</p>		DO NOT SCALE DRAWING
<p>NINGBO DEGSON ELECTRICAL CO., LTD</p>		<p>15EDGVC-3.5/3.81-XXP-1Y-00A(H)</p>		<p>REV</p>	
<p>CUSTOMER DRAWING</p>		<p>DRAWING NO.:</p>		<p>DO</p>	
<p>SHEET</p>		<p>SCALE</p>		<p>1/1</p>	
<p>1:1</p>		<p>1</p>		<p>1</p>	