

公差等级/General Tolerances(mm)		公差等级/General Tolerances(mm)										公差等级/General Tolerances(mm)	
0	>3	>6	>10	>18	>30	>50	>80	>120	>180	>250	>315	>400	0.1/10
~	~	~	~	~	~	~	~	~	~	~	~	~	~
3	6	10	18	30	50	80	120	180	250	315	400	500	>500
±0.12	±0.18	±0.22	±0.26	±0.31	±0.37	±0.57	±0.80	±0.93	±1.05	±1.15	±1.60	±2.20	±2.50
±2													±2

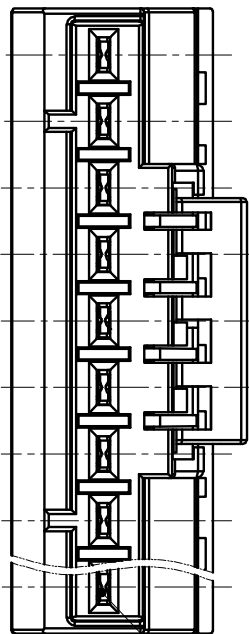
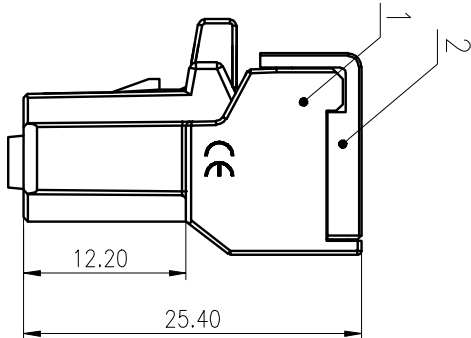
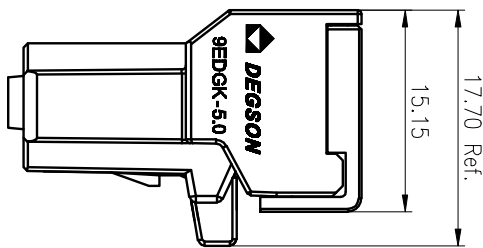
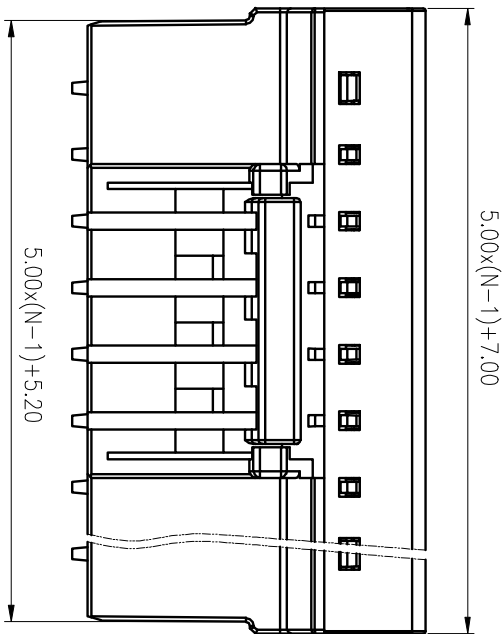
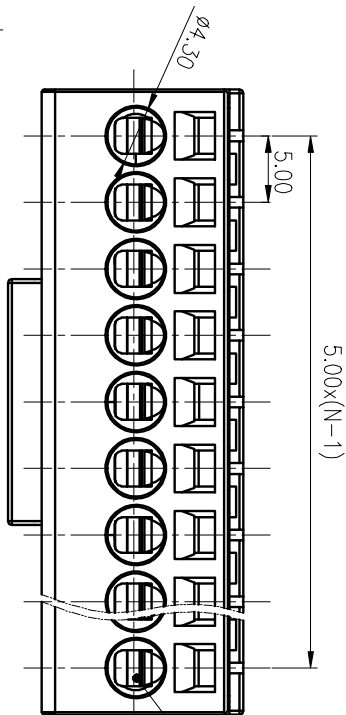

4	Spring	Stainless steel	/
3	Clamp	Copper alloy	Au Plated Aero
2	Cover	PA66-GF	UL94V-0
1	Housing	PA66-GF	UL94V-0
ITEM	NAME OF PART	MATERIAL	NOTES
UL 标准 / UL Standard:	B	C	D
额定电压/额定 / Rated Voltage(V)/Current(A)	300/14.5	/	300/10
IEC 标准 / IEC Standard:			
过压类别 / Overvoltage Category / 污染等级 / Pollution Degree	III / 3	III / 2	II / 2
额定电压/额定 / Rated Voltage(V)/Current(A)	160/20	160/20	320/20
额定冲击电压 / Rated Impulse Voltage(KV)	4	4	4
绝缘电阻 / Insulation Resistance / 绝缘电阻 / Insulation Resistance	0.2~2.5/28~14		
导体截面积 / Conductor Cross-sectional Area / 导体截面积 / Conductor Cross-sectional Area	5.0/N=02~14P		
间距 / Pitch(mm) / 间距 / Pitch(mm)	8-9		
剥线长度 / Stripping length(mm)	-40~+105		
工作温度范围 / Operating temperature(°C)	Yes		
符合 RoHS 环保要求 / Conform to RoHS	Yes		

MATERIAL: / SURFACE: /

MAT NO.: / STATUS: /

APPD: LI QL 2020.03.30 NAME: **DEGSON® NINGBO DEGSON ELECTRICAL CO., LTD**

CHKD: MAEK 2020.03.30 9EDGK-5.0-XXP-1Y-00A(H)

DFT: Wangw 2020.03.30 DRAWING NO.: 9EDGK-5.0-C02 TYPE: CUSTOMER DRAWING SCALE: 2:1 SHEET 1/4

REV	ECN	DESCRIPTION	DFT	DATE
1				
2				
3				
4				

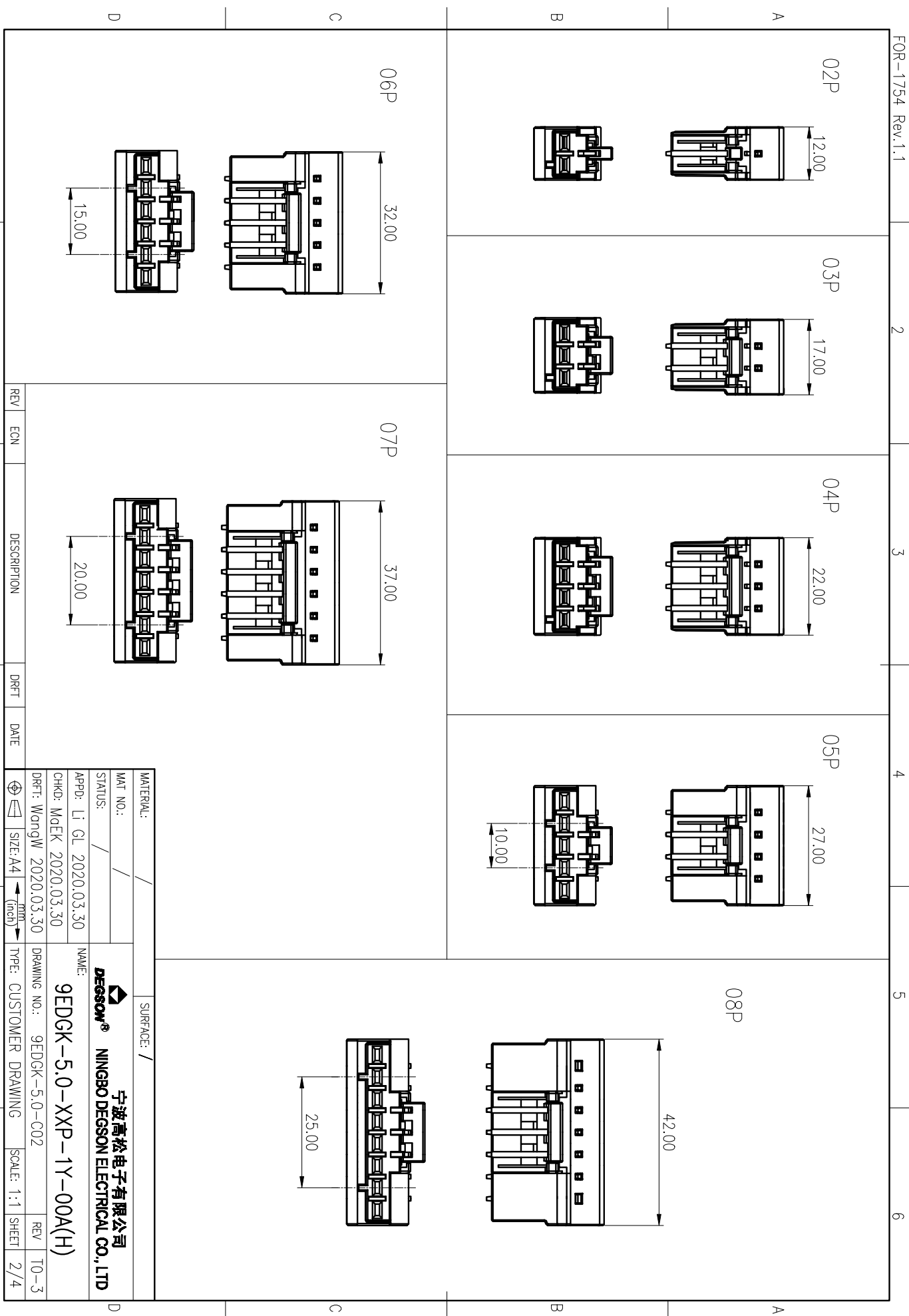

REV	ECN	DESCRIPTION	DRAFT	DATE

MATERIAL: /	SURFACE: /
MAT NO.: /	NINGBO DEGSON ELECTRICAL CO., LTD 宁波德松电子有限公司
STATUS: /	
APPD: LI QL 2020.03.30	
CHKD: MoEK 2020.03.30	
DRAFT: WangW 2020.03.30	
DRAWING NO.: 9EDGK-5.0-C02	NAME: 9EDGK-5.0-XXP-1Y-00A(H)
TYPE: CUSTOMER DRAWING	SCALE: 1:1
REV	T0-3
	2/4

1 2 3 4 5 6

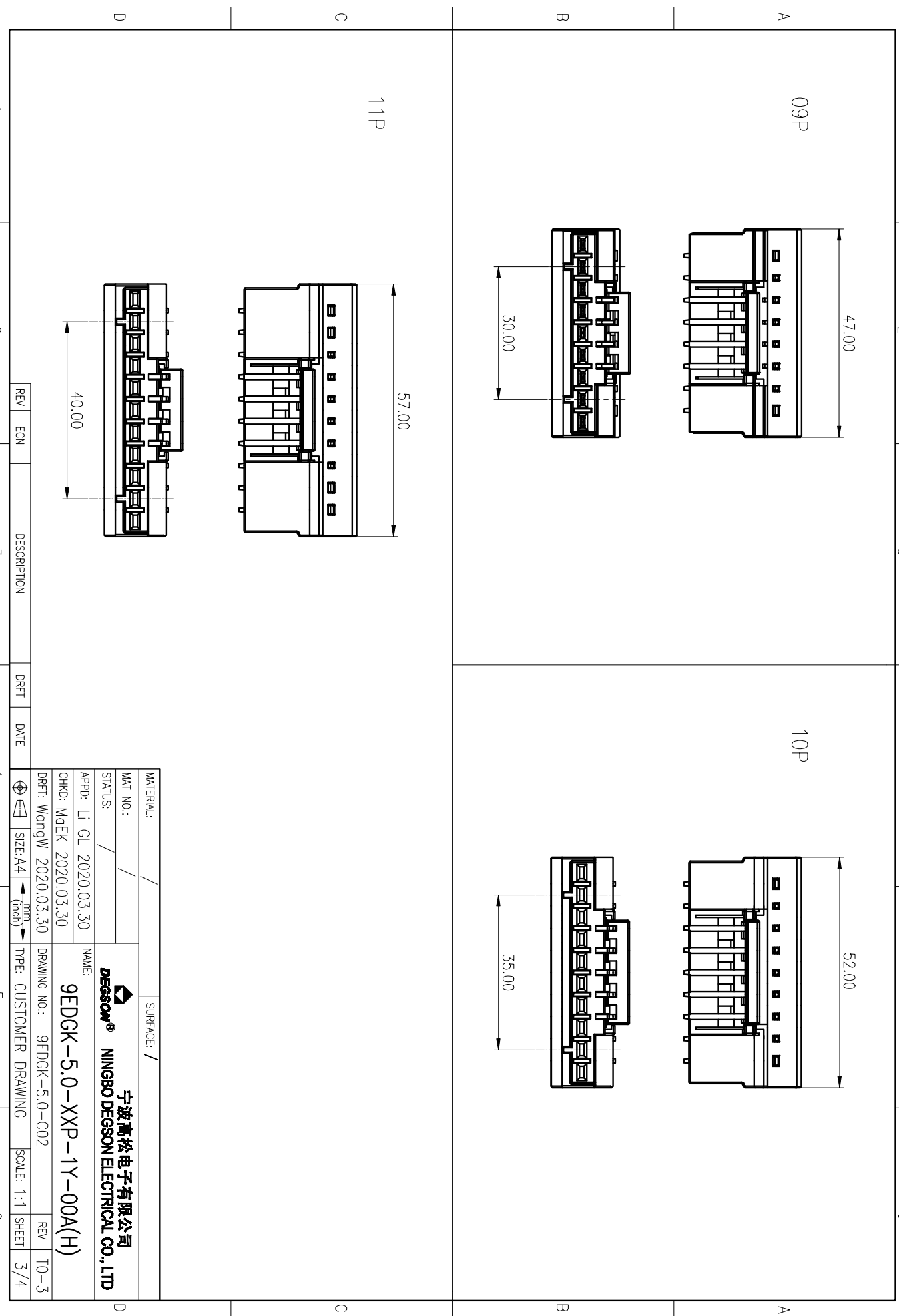

REV	ECN	DESCRIPTION	DRAFT	DATE	MATERIAL:	SURFACE: /
					MAT NO.: /	
					STATUS: /	
					APPD: LI GL 2020.03.30	NAME: DEGSON® NINGBO DEGSON ELECTRICAL CO., LTD
					CHKD: MaEK 2020.03.30	9EDGK-5.0-XXP-1Y-00A(H)
					DRAFT: WangW 2020.03.30	DRAWING NO.: 9EDGK-5.0-C02
					SIZE: A4	TYPE: CUSTOMER DRAWING
					SCALE: 1:1	REV TO-3
						3/4 SHEET

A

12P

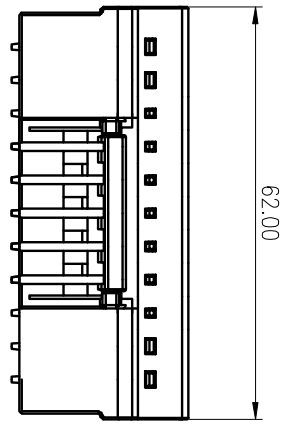

62.00

B

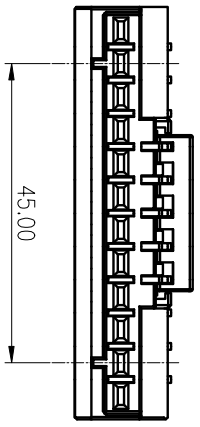

45.00

13P

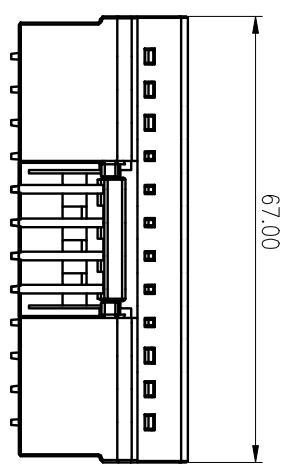

67.00

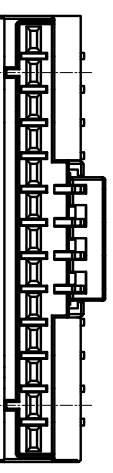

50.00

14P

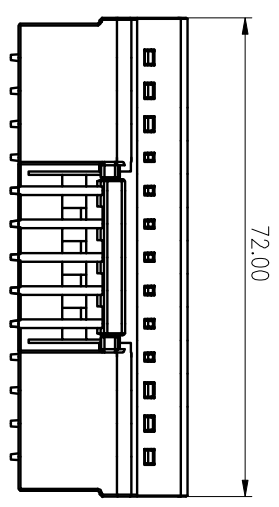

72.00

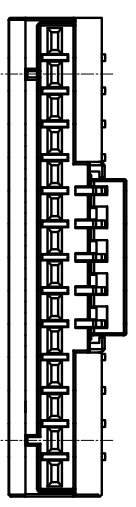

55.00

REV	ECN	DESCRIPTION	DRAFT	DATE

MATERIAL: /	SURFACE: /
MAT NO.: /	
STATUS: /	
APPR: LI GL 2020.03.30	NAME: DEGSON 宁波高松电子有限公司 NINGBO DEGSON ELECTRICAL CO., LTD
CHKD: MaEK 2020.03.30	9EDGK-5.0-XXP-1Y-00A(H)
DRAFT: WangW 2020.03.30	DRAWING NO.: 9EDGK-5.0-C02
	TYPE: CUSTOMER DRAWING
	SCALE: 1:1
	REV: T0-3
	SHEET: 4/4