

Dept	
Qty	
DC	1
ED	1
IE	1
ISO	1
PD	1
R&D	1
SD	1
QA	1
QC	1
QF	1

The information provided herein is from CONNELY Electronic Co., Ltd. and is confidential. Any disclosure to a party other than the recipient is prohibited. The intellectual properties and its rights contained herein, including but not limited to, trademarks, patents, copyrights, trade secrets, and technical know-how, are owned exclusively by CONNELY or its affiliates. Unauthorized use or reproduction of any part of this document is strictly prohibited. CONNELY may enforce its intellectual property rights at its own discretion, failures or delays to exercise such rights does not constitute a waiver of such rights. Its use in any format or manner. CONNELY may enforce its intellectual property rights at its own discretion, failures or delays to exercise such rights does not constitute a waiver of such rights.

REV.	DESCRIPTION	DRAWN	CHECKED	APPROVED
A	NEW RELEASE	JLZ 03/16/15'	HZW 03/16/15'	LJC 03/16/15'
B	DRAWING UPDATE	JLZ 01/11/19'		

Notes:
 Specifications:
 1. Contact Resistance: 20mΩ Max.
 2. Insulation Resistance: 1000MΩ Min.
 3. Dielectric Withstanding Voltage: 600V AC(rms) For 1 Minute.
 4. Current Rating:3A.
 5. Temperature: -40°C--+105°C.
 Materials:
 1. Contact Material: Copper Alloy.
 2. Contact Plating: Gold Plating Over Nickel.
 3. Insulator Material: PBT,Black,UL94-V0.
 Product Number Code:

DS1023-33 - X X X
 Contact plating
 F1: Full glood flash
 Mounting type
 S: Straight type
 No.of contacts
 1x2 - 1x40
 2x2 - 2x40

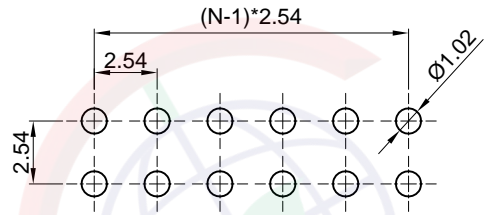
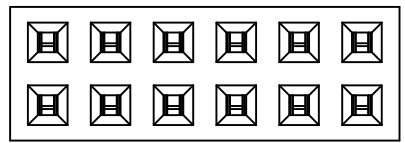
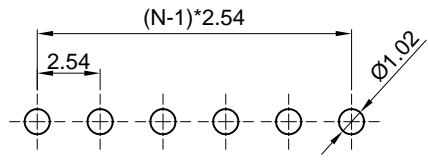
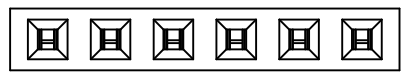

Recommend PCB layout
 (Tolerance:±0.05)

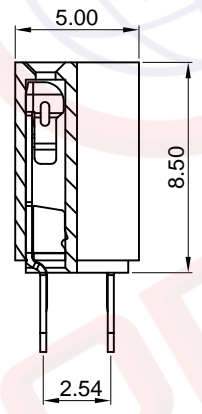
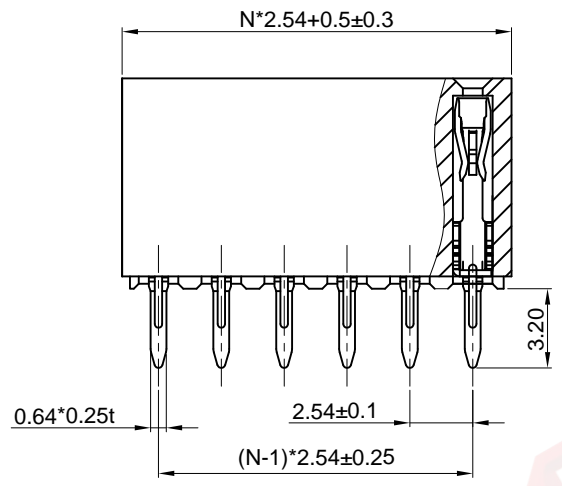

Double row
 N=No.of contacts/2

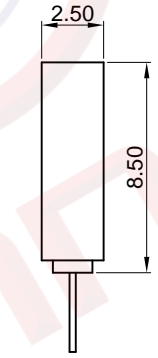

Single row
 N=No.of contacts

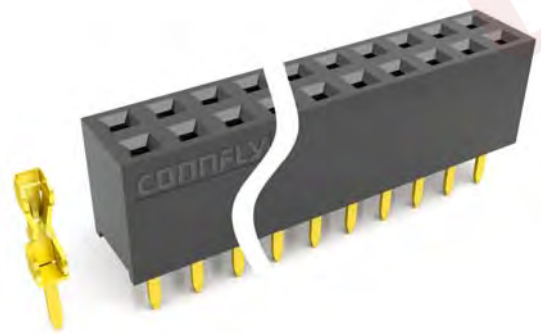

(Series Image-Reference Only)

GENERAL TOLERANCE		ANGLE TOLERANCE	
X.	±0.60	X.	±5°
.X	±0.38	.X	±3°
.XX	±0.25	.XX	±2°
DRAWING TYPE		CUSTOMER	
SCALE		1:1	SHEET 1 OF 1
DRAWING NO.		C-DS1023-33-XXX-B	

PROJECTION		TITLE	2.54mm FEMALE HEADER V/T TYPE H=8.5mm WITH HIGH O TYPE TERMINAL
UNITS	mm	SERIES	DS1023-33 SERIES
SHEET SIZE	A4		

晨翔电子有限公司
 CONNELY CONNELY ELECTRONIC CO. LTD