

The information provided herein is from CONNELY Electronic Co., Ltd. and is confidential. Any disclosure to a party other than the recipient is prohibited. The intellectual properties and its rights contained herein, including but not limited to, trademarks, patents, copyrights, trade secrets, and technical know-how, are owned exclusively by CONNELY or its affiliates. Unauthorized use or reproduction of any part of this document is strictly prohibited. CONNELY may enforce its intellectual property rights at its own discretion, failures or delays in exercising such rights does not constitute a waiver of such rights.

[Female]

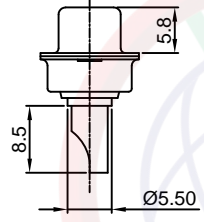

[Male]

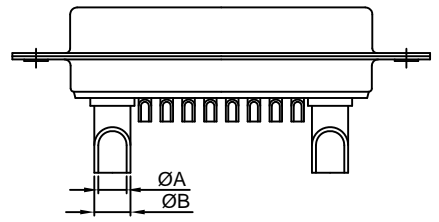
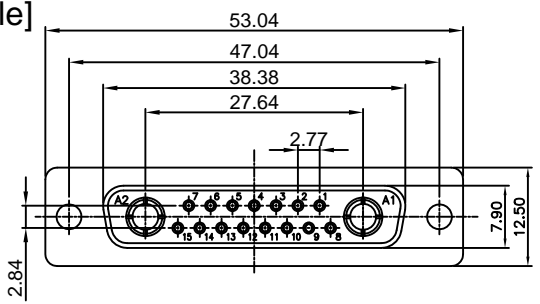
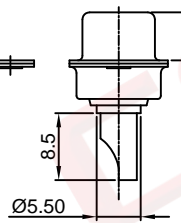
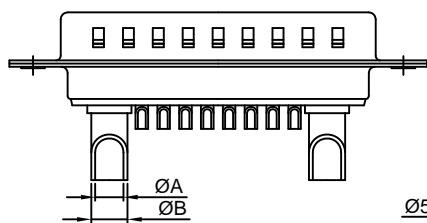
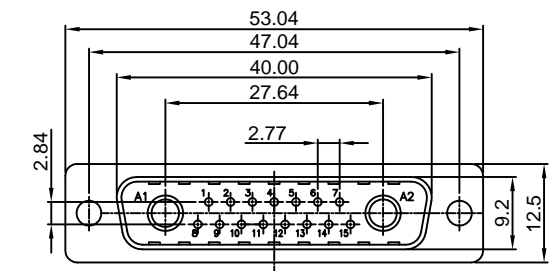

Type	Current rating	ØA	ØB
1	10A	Ø1.7	Ø2.5
2	20A	Ø2.7	Ø3.6
3	30A	Ø3.6	Ø4.5
4	40A	Ø4.6	Ø5.5

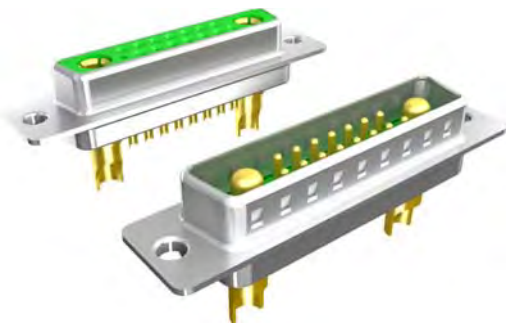

(Series Image-Reference Only)

REV.	DESCRIPTION	DRAWN	CHECKED	APPROVED
A	NEW RELEASE	LJC 01/17/09'		
B	DRAWING UPDATE	JLZ 08/31/20'		

Notes:

- Electrical characteristics:
 - Contact resistance: 20mΩ Max. Initial.
 - Dielectric withstanding voltage: 500V AC(rms)for 1 minute.
 - Insulation resistance: 1000MΩ Min.
 - Current rating: 5A/10~40A(Power pin)
 - Voltage rating: 300V
- Environment characteristics:
 - Temperature range: -40° C ~ +105° C.
- Mechanical characteristics:
 - Durability: 500 cycles.
 - Contact retention force: 1Kgf Minimum.
- Materials:
 - Shell: SPCC.
 - Contact: Copper alloy.
 - Insulator: Thermoplastic UL 94V-0,Glass fiber filled.
- Part number code:

DS1033-02- X X X X X

- Current rating
 - 1: 10A
 - 2: 20A
 - 3: 30A
 - 4: 40A
- Contact plating
 - 8: Full gold flash
 - C: Full 3u" gold
- Shell plating
 - N: Fornt shell nickel,Back shell tin
- Housing color
 - B: Black
 - W: White
 - L: Blue
- Connector type
 - M: Male
 - F: Female

GENERAL TOLERANCE	ANGLE TOLERANCE	PROJECTION		TITLE	MACHINE PIN D-SUB 15+2
X. ±0.60	X. ±5°	UNITS	mm	SOLDER TYPE	
.X ±0.38	.X ±3°	SHEET SIZE	A4	SERIES	DS1033-02 SERIES
.XX ±0.25	.XX ±2°	晨翔电子有限公司 CONNFLY CONNFLY ELECTRONIC CO. LTD			
DRAWING TYPE	CUSTOMER				
SCALE	1:1 SHEET 1 OF 1				
DRAWING NO.	C-DS1033-02-XXXX-B				