

REV.	DESCRIPTION	DRAWN	CHECKED	APPROVED
A	NEW RELEASE	JLZ 07/27/15'		

NOTES:

1. MAIN SPECIFICATIONS

- . Housing material: NYLON 66
- . Contact material: Copper Alloy
- . Rated voltage: 125V
- . Rated current: 2.0A
- . Contact resistance: $\leq 30m\Omega$
- . Insulation resistance: $\geq 1000M\Omega$
- . Withstanding voltage: 500V,AC 1 minute
- . Temperature range: $-25 \sim +85^{\circ}C$
- . Recommend PC board thickness:1.6mm

2. PRODUCT NUMBER CODE:

DS1066-05 - X X X X X X

- Contact type
X: W/O Kink
- Housing Color
V: Ivory
W: White
- Contact Plating
6: Tin
- Mounting type
V: V/T type
R: R/A type
- Connector type
M: Male
- No. of contact
2 to 15

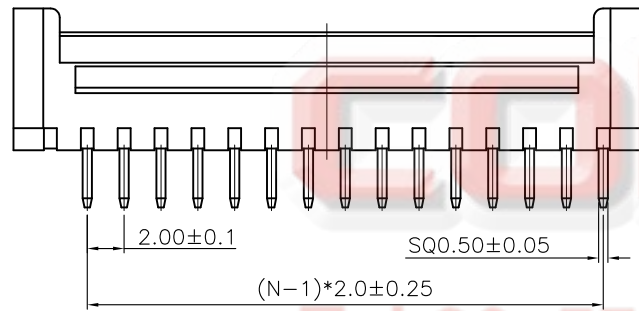
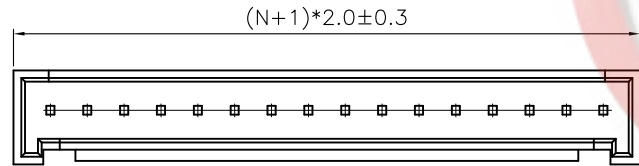

V/T TYPE

R/A TYPE

N=No. of contact

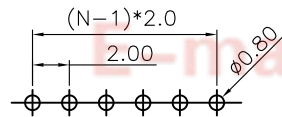

RECOMMEND PCB LAYOUT
(TOLERANCE= ± 0.05)

GENERAL TOLERANCE		ANGLE TOLERANCE	
X.	± 0.60	X.	$\pm 5^{\circ}$
.X	± 0.38	.X	$\pm 3^{\circ}$
.XX	± 0.25	.XX	$\pm 2^{\circ}$

PROJECTION	TITLE
	2.0mm Wafer & Housing PHS TYPE
UNITS	mm
SHEET SIZE	A4
SERIES	DS1066-05 SERIES

DRAWING TYPE	CUSTOMER
SCALE	1:1 SHEET 1 OF 2
DRAWING NO.	C-DS1066-05-XXXXX-A



晨翔电子有限公司

CONNFLY CONNFLY ELECTRONIC CO. LTD

REV.	DESCRIPTION	DRAWN	CHECKED	APPROVED
A	NEW RELEASE	JLZ 07/27/15'		

Terminal

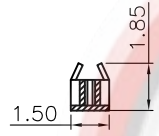
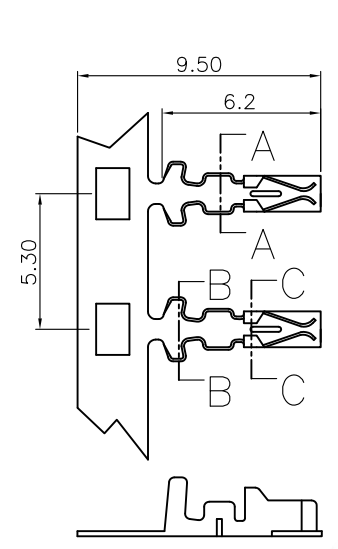

C-C

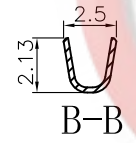

B-B

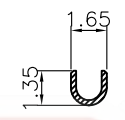

A-A

NOTES:

1. MAIN SPECIFICATIONS

- . Housing material: NYLON 66
- . Contact material: Copper Alloy
- . Rated voltage: 250V
- . Rated current: 1A
- . Contact resistance: $\leq 30m\Omega$
- . Insulation resistance: $\geq 1000M\Omega$
- . Withstanding voltage: 500V,AC 1 minute
- . Temperature range: $-25 \sim +85^{\circ}C$
- . Recommend PC board thickness:1.6mm

2. PRODUCT NUMBER CODE:

Terminal

T - DS1066-05 - S C X 0 0

Contact Plating
6: Tin

Housing

I - DS1066-05 - S C X 0 X

No.of hole
02~15
Housing color
V: Ivory
W: White

Housing

N=No.of hole

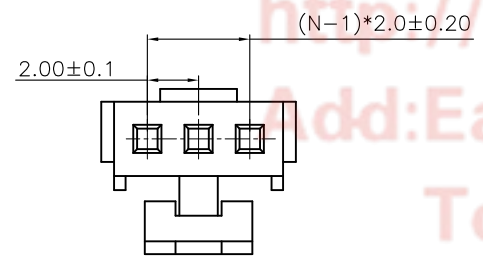
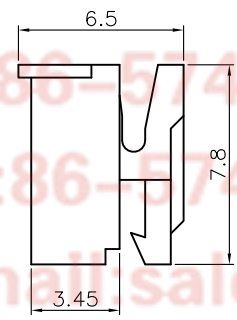
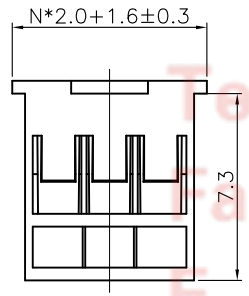

Tel:86-574-63508787
Fax:86-574-63510817
E-mail:sale@connfly.com

http://www.connfly.com

Add:East Industry Zone, Kuyi

Town Cixi, Ningbo, China

P.C:315333

GENERAL TOLERANCE		ANGLE TOLERANCE	
X.	±0.60	X.	±5°
.X	±0.38	.X	±3°
.XX	±0.25	.XX	±2°
DRAWING TYPE		CUSTOMER	
SCALE		1:1	SHEET 2 OF 2
DRAWING NO.		C-DS1066-05-XXXXX-A	

PROJECTION	TITLE
	2.0mm Wafer & Housing PHS TYPE
UNITS	mm
SHEET SIZE	A4
SERIES	DS1066-05 SERIES



晨翔电子有限公司

CONNFLY CONNFLY ELECTRONIC CO. LTD